

AQUA RGBW DMX

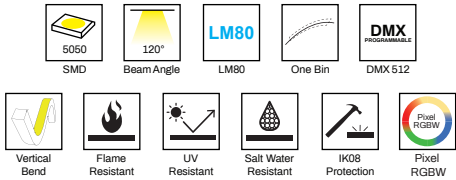
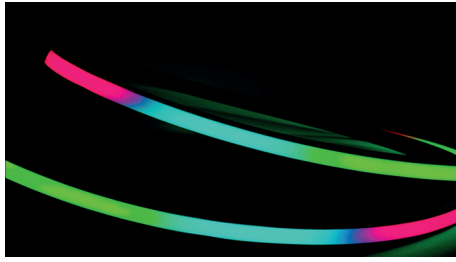

DESCRIPTION:

AQUA RGBW DMX 512 vertical bend series constructed using Silicon extrusion process. Uniform, dot free light emission, good appearance consistency. Anti-yellowing, high temperature and corrosion resistance, weak acid and alkali resistance UV proof for true outdoor applications. Easy installation with clips and bendable track. Cuttable for Flexible application. Control mode : DMX 512.

TECHNICAL DETAILS:

Power : 15W/M
 Voltage : DC24V
 CRI >90
 IC Chips : SM18522PS
 Length/Reel : 5M/10M
 Cutting length : 83.3mm
 Led Qty : 84LEDs/M
 Pixels : 12 pixels/M
 Working Temperature : -25~55°C
 Storage Temperature : -30~80°C
 Voltage Range : 23~25V dc
 Reverse Voltage : 25V dc
 Warranty : 5 years

LUMENS PER WATTAGE:

CCT	15W
R	80lm/W
G	110lm/W
B	27lm/W
W/2700K	166lm/W
W/3000K	175lm/W
W/4000K	184lm/W
W/57000K	189lm/W

RGBW(3K) 3255lm/M Lumen output may vary depending on RGBW(27K) RGBW(4K) and RGBW(57K).

INSTALLATION : Vertical Bend

Product Code : 8961616

DIMENSION:

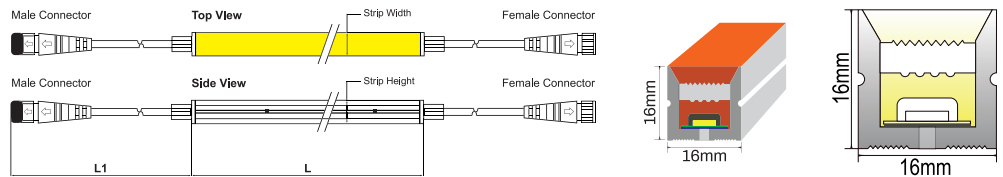

LIGHT DISTRIBUTION:

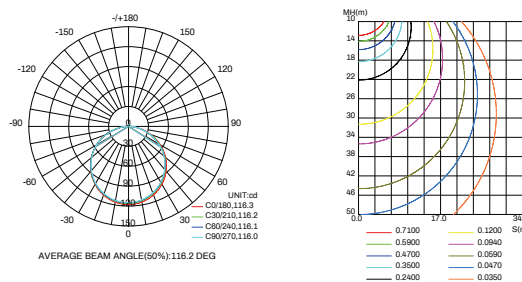

BENDING:

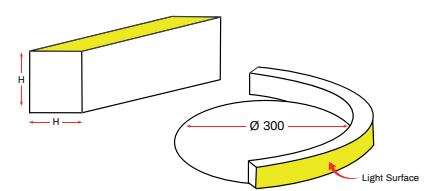

End cap

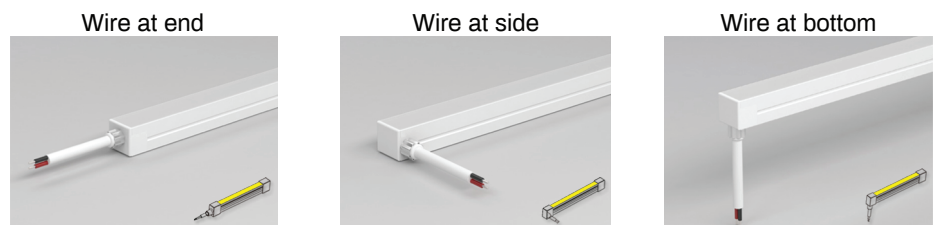

Standards
EN 60598-1
EN 60598-2-2
EN 60598-3-2

Order Code Ex : 8961616	15	83
Product Code	Power	CCT
8961616	15-15W	83 RGBW-DMX

Pluxb luminaires are developed with globally recognized and tested components suppliers, however as per international standards tolerance in initial flux and connected load is at ±5%. Unless stated otherwise, the values apply to an ambient temperature of 25°C

ACCESSORIES

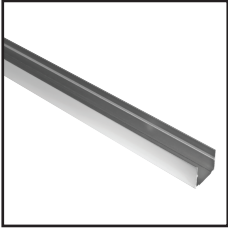

Aluminium Profile
Order Code : 8961616-01
Dimension : L1000xW18xH18mm
Material : aluminium
Color : silver

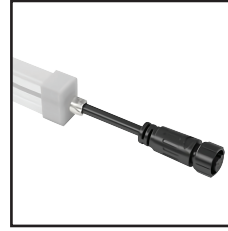

End Cap 5PIN
Order Code : 8961616-06
Color : white
Cable entry : front/side/bottom
Picture : front



Curved Profile
Order Code : 8961616-02
Dimension : L1000xW17xH12.7mm
Material : stainless steel
Color : silver

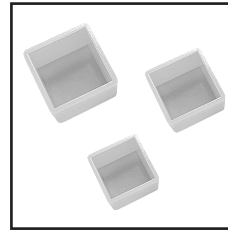

Closed End Cap
Order Code : 8961616-07
Material : silicone
Color : white



Mounting Clips
Order Code : 8961616-03
Dimension : L20xWW18xH18mm
Material : stainless steel
Color : silver
Each meter led strips needs
2 clips + 2 screws

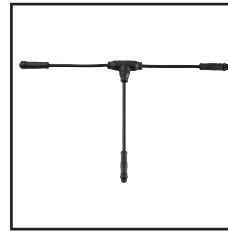

IP67 T Type Connector
Order Code : 8961616-08
Wire Gauge : 0.326mm²/22AWG
Protection : IP67 (Mated)



IP67 Connector 5PIN
Order Code : 8961616-04
Wire gauge : 0.326mm²/22AWG
Protection : IP67 (Mated)
Connector type : Male



Scissor
Order Code : 8961616-09



IP67 Connector 5PIN
Order Code : 8961616-05
Wire gauge : 0.326mm²/22AWG
Protection : IP67 (Mated)
Connector type : Female

ADDITIONAL INFO

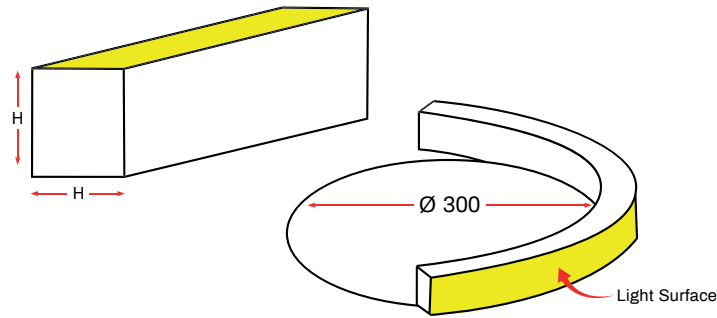

- ▶ Please light it up for a quick check before installation.
- ▶ Bending diameter of AQUA RGBW DMX 1616 is 300mm, do not bend to side direction, or bend too sharp or twist. If bend it wrongly, PCB inside will be damaged and the lighting fixture will not turn on.
- ▶ During installation, please make sure there are at least two workers to cooperate together and strictly follow the instruction manuals.
- ▶ Warranty : All LED light are warranted to be free from defects in product itself for 5 years from the date of purchase. This warranty does not cover failures due to abuse, misuse, improper handling, act of nature, negligence, normal wear, accidental damage, repairs made by the purchaser or incorrect voltage conditions.

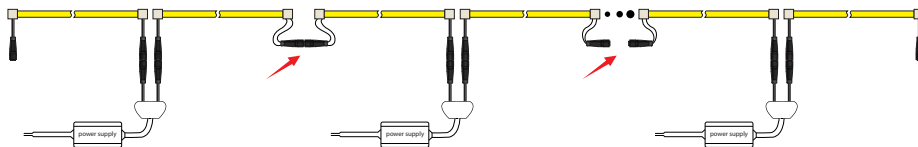

Note:

-15W/M Max. 7mtr run length to double side feed.

-The given data are typical values due to the tolerances of the production process and the electrical components, values for light output and electrical power can vary up to 5%.

WIRING DIAGRAM

DMX

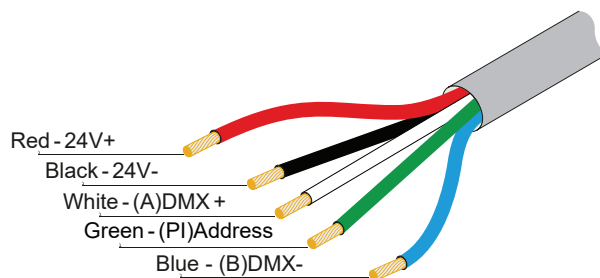
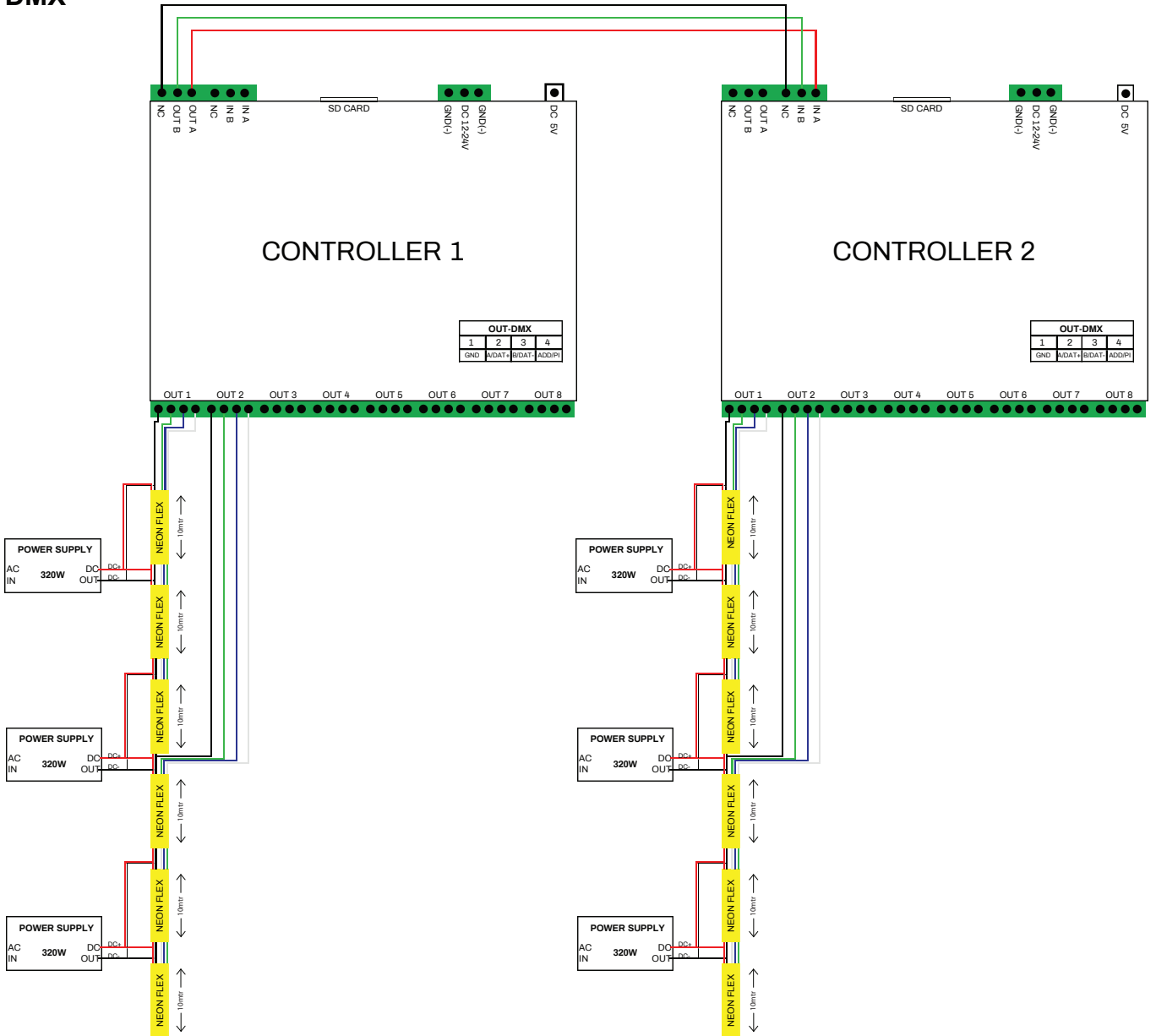

GENERAL MOUNTING

LED neon flex can be fastened to surfaces using appropriate accessories available from distributor. Please refer to data sheets or contact technical support for a copy. The use of glues and resins as fixing agents should be avoided. Use of glues and resins may invalidate the warranty of the product unless its use is agreed in writing by distributor as part of a detailed project specification.

The images indicate one type of fixing available in the accessories range. The different fixings serve obvious purposes, however when in doubt technical support should be contacted.

Quantities of accessories and fixings are dependent on the type and its effect on the variant it's being used with. Care should be taken to ensure drooping is avoided, and to ensure that is fastened adequately to avoid stresses on itself.

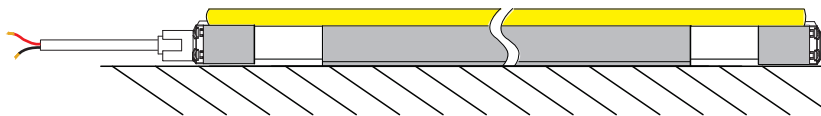
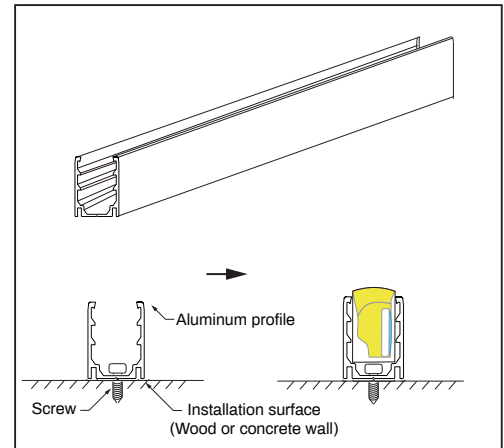

Press the flex light into mounted aluminum channel in one direction.

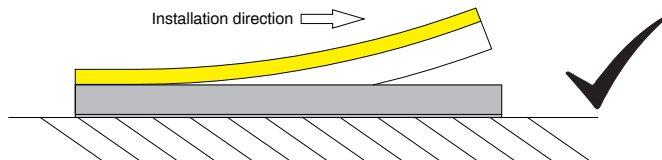

Incorrect installation like below picture could lead to light failure.

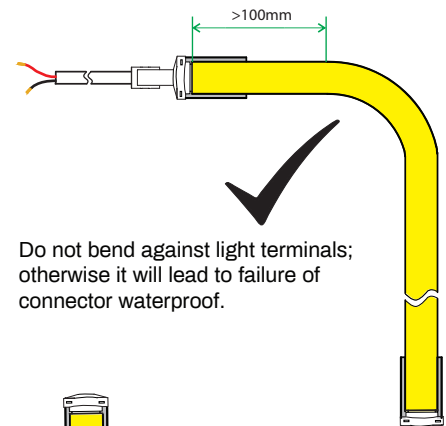
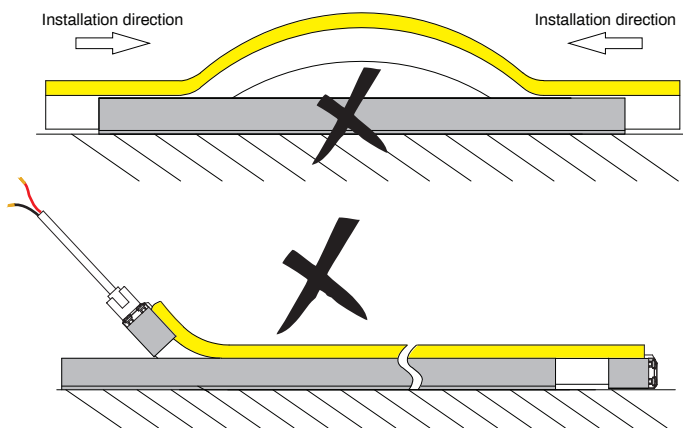

Do not bend against light terminals; otherwise it will lead to failure of connector waterproof.

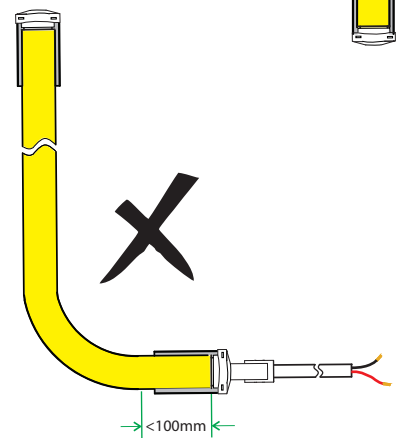

Ensure the feeding cable not bear force, keep the head 10mm in natural loose.

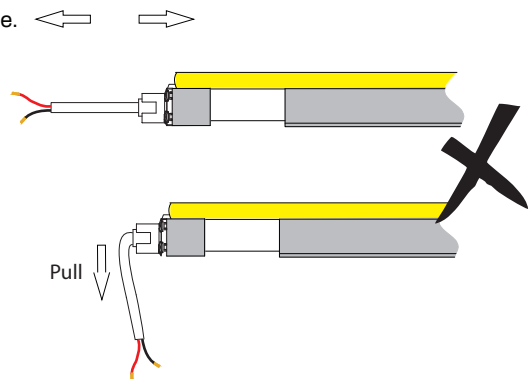
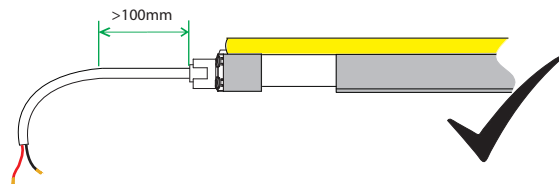

Mount the cable junction in hermetic enclosure like waterproof junction box in outdoor application.

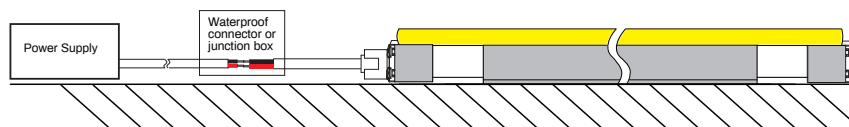

INSTALLATION

Attention

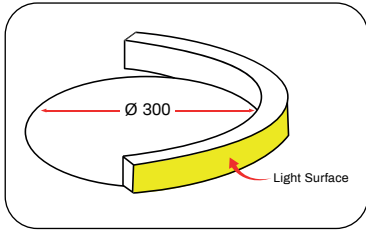

1. Correct bending way.

Installation

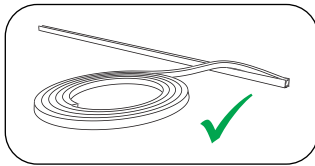

1. During LED strip installation, ensure to uncoil the strip loop by loop and maintain perpendicular alignment with the mounting profile. Avoid twisting or knoting of the strip at all times.

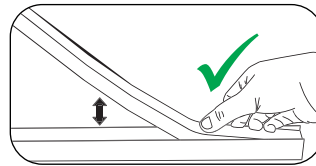
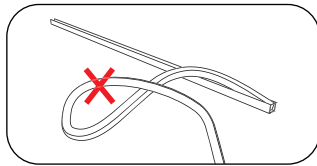

2. Align the LED strip with the opening of the profile, gently lift and press the strip into the profile, and strictly avoid excessive bending or lifting of the strip.

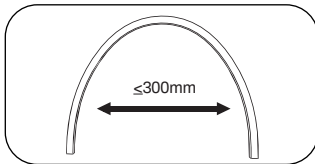
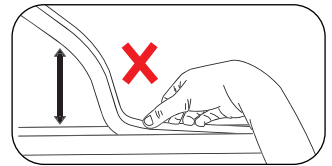

3. Align the LED strip with the opening of the profile, gently lift and press the strip into the profile, and strictly avoid excessive bending or lifting of the strip.

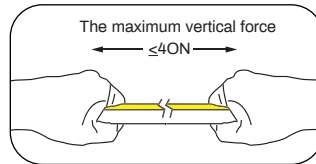
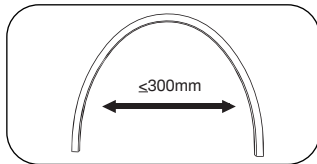

The safe tensile force for the LED strip shall be $\le 4\text{ON}$. Excessive force may damage the internal circuitry.

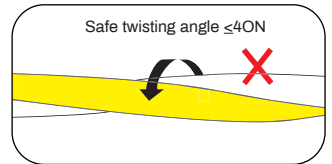

The safe twisting angle for the LED strip shall not exceed 180° .

Warning sign

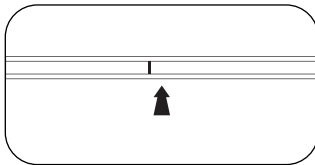

Cuttable Marking Area (on the bottom or side of the product).

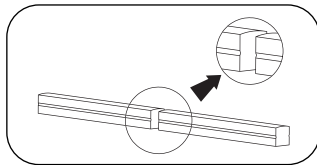

Neat and smooth cut.

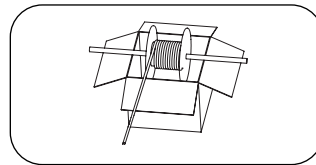

Mount the roll on a rod over the box and rotate to use.

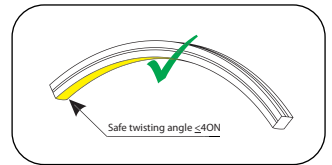

Top Bend.

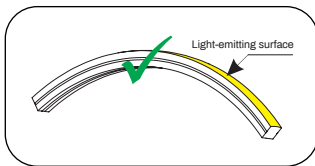

Side Bend.

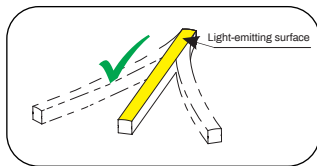

Free Bend.

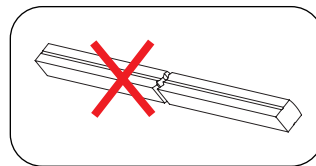

Do not leave uneven cuts.

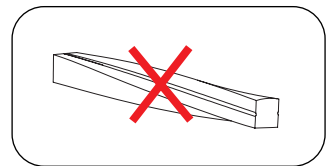

Do not twist during use.

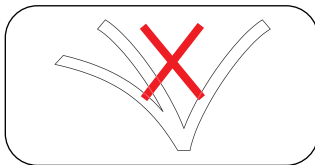

Repeated bending may damage electronic circuits.

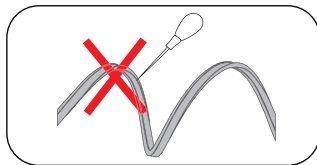

Do not puncture or scratch with sharp objects.

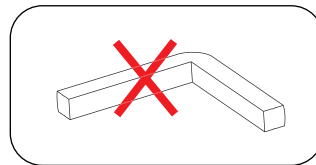

Do not bend at sharp angles.

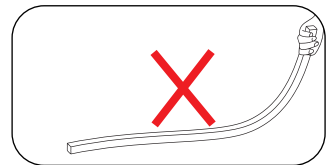

Do not jerk or yank when using the product.

1. The cutting marks are located on the PCB. Refer to the product cutting line window or laser markings on the surface to identify the trimming position.
2. During transportation and application, please observe the above warning labels. Proper handling ensures optimal performance and user satisfaction.