

## AQUA RGB DMX

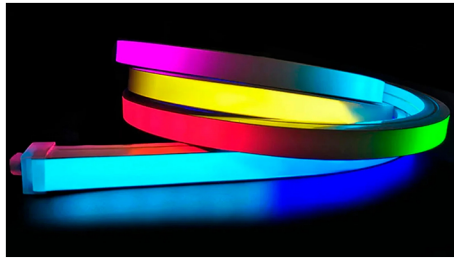

### DESCRIPTION:

AQUA RGB DMX vertical bend series constructed using Silicon extrusion process. Uniform, dot free light emission, good appearance consistency. Anti-yellowing, high temperature and corrosion resistance, weak acid and alkali resistance UV proof for true outdoor applications. Easy installation with clips and bendable track. Cuttable for Flexible application. Control mode : DMX

### TECHNICAL DETAILS:

Power : 12W/M  
 Voltage : DC24V  
 CRI >90  
 Length/Reel : 5M/10M  
 Cutting length: 100mm  
 Led Qty : 60LEDs/M  
 Pixels : 10 pixels/M  
 Working Temperature : -25~55°C  
 Storage Temperature : -30~80°C  
 Voltage Range : 23 ~25V dc  
 Reverse Voltage : 25V dc  
 Warranty : 5 years

### LUMENS PER METER:

CCT	RGB
12W	360lm

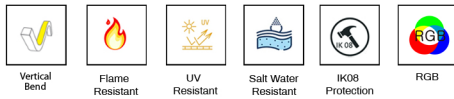

### INSTALLATION : Vertical Bend

Product Code : 8951310

### DIMENSION:

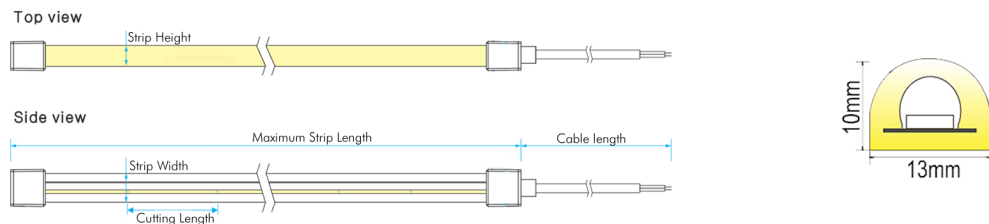

### LIGHT DISTRIBUTION:

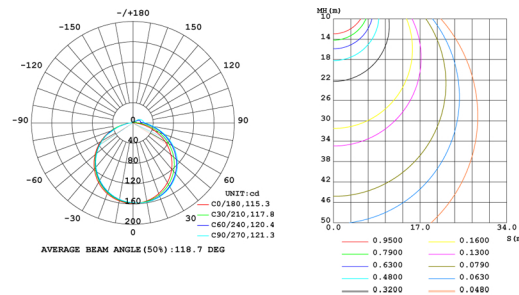

### BENDING:

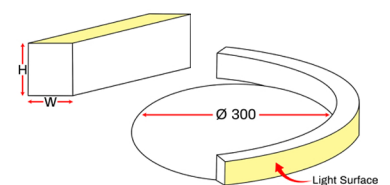

### End cap

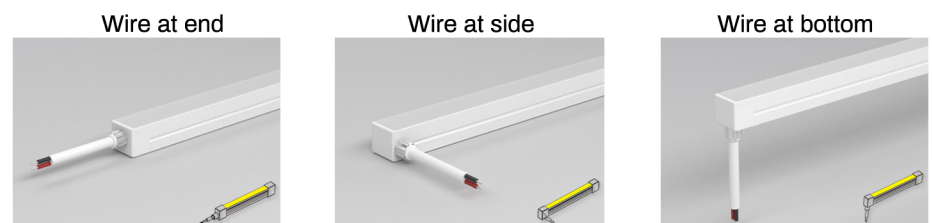

### Standards

- EN 60598-1
- EN 60598-2-2
- EN 60598-3-2

Order Code Ex : 8951310 | 12 | 93  
 Product Code | Power | CCT  
 8951310 | 12-12W | 93-RGB DMX

Pluxb luminaires are developed with globally recognized and tested components suppliers, however as per international standards tolerance in initial flux and connected load is at ±5%. Unless stated otherwise, the values apply to an ambient temperature of 25°C

## ACCESSORIES



Aluminium Profile  
 Order Code: 8951310-01  
 Dimension: L1000xW11.5xH15.5mm  
 Material: aluminium  
 Color: silver

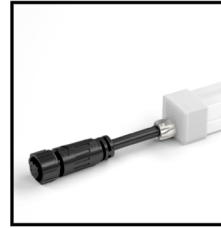

End Cap 5PIN Digital  
 Order Code: 8951310-06  
 Color: white  
 Cable entry: front/side/bottom  
 Picture: front

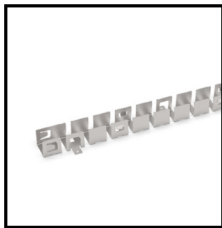

Curved Profile  
 Order Code: 8951310-02  
 Dimension: L1000xW11.5xH15.5mm  
 Material: stainless steel  
 Color: silver

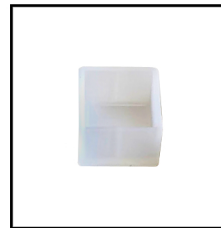

Closed End Cap  
 Order Code: 8951310-07  
 Material: silicone  
 Color: white

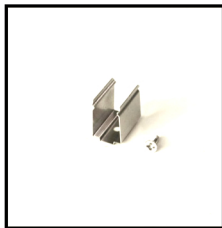

Mounting Clips  
 Order Code: 8951310-03  
 Dimension: L30xW11.5xH15.5mm  
 Material: stainless steel  
 Color: silver  
 Each meter led strips needs  
 2 clips + 2 screws



IP67 Signal Connector  
 Order Code: 8951310-08  
 Wire Gauge: 0.326mm<sup>2</sup>/22AWG  
 Protection: IP67 (Mated)



IP67 Connector 5PIN Digital  
 Order Code: 8951310-04  
 Wire gauge: 0.326mm<sup>2</sup>/22AWG  
 Protection: IP67 (Mated)



IP67 T Type Connector  
 Order Code: 8951310-09  
 Wire Gauge: 0.326mm<sup>2</sup>/22AWG  
 Protection: IP67 (Mated)



IP67 Connector 5PIN Digital  
 Order Code: 8951310-05  
 Wire gauge: 0.326mm<sup>2</sup>/22AWG  
 Protection: IP67 (Mated)



Scissor  
 Order Code: 8951310-10

## ADDITIONAL INFO.

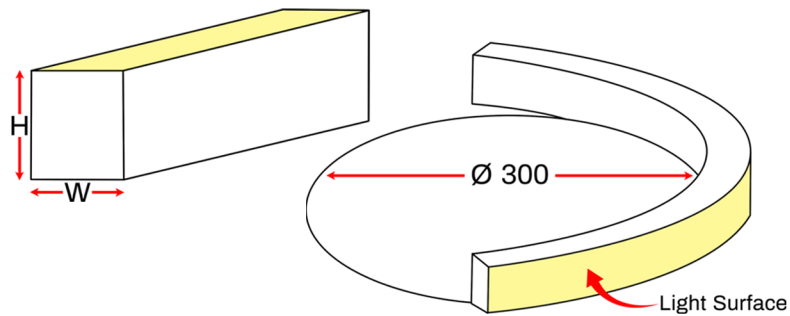

- ▶ Please light it up for a quick check before installation.
- ▶ Bending diameter of AQUA RGB DMX 1310 is 300mm, do not bend to side direction, or bend too sharp or twist. If bend it wrongly, PCB inside will be damaged and the lighting fixture will not turn on.
- ▶ During installation, please make sure there are at least two workers to cooperate together and strictly follow the instruction manuals.
- ▶ Warranty: All LED light are warranted to be free from defects in product itself for 5 years from the date of purchase. This warranty does not cover failures due to abuse, misuse, improper handling, act of nature, negligence, normal wear, accidental damage, repairs made by the purchaser or incorrect voltage conditions.

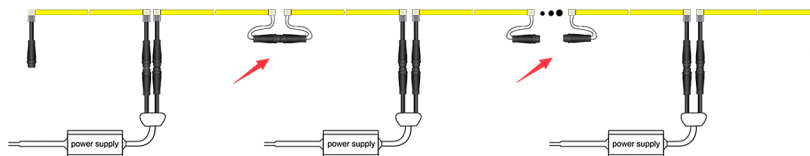

**Note:**

-12W/M Max. 10mtr run length to single side feed.

-The given data are typical values due to the tolerances of the production process and the electrical components, values for light output and electrical power can vary up to 5%.

# WIRING DIAGRAM

## DMX

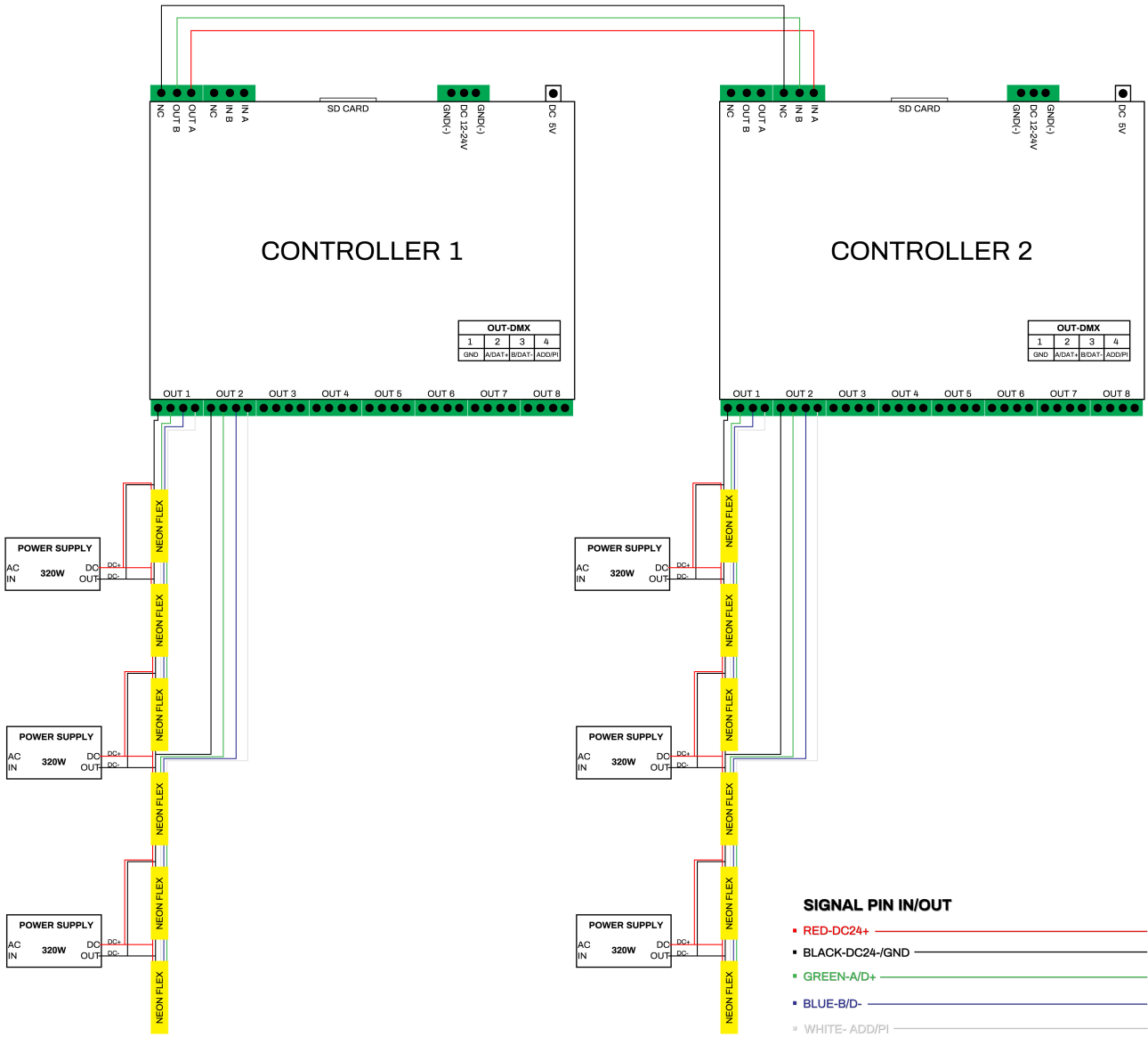

## DMX

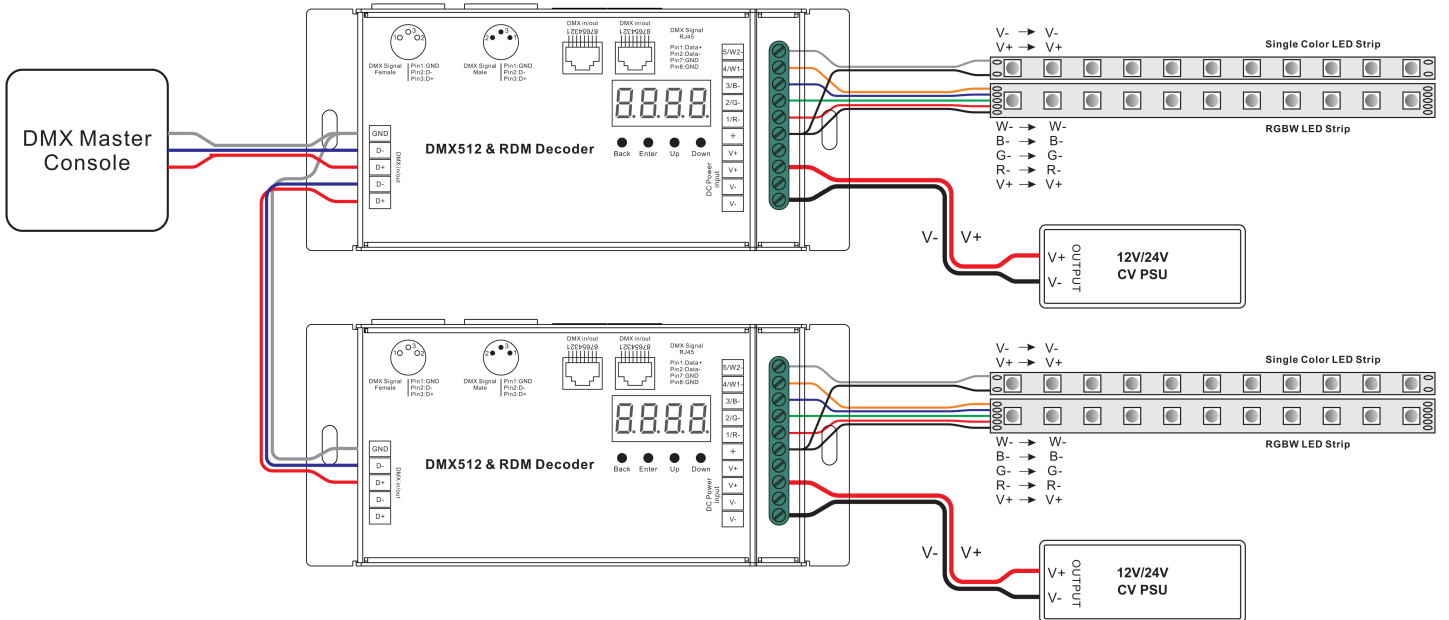

## GENERAL MOUNTING

LED neon flex can be fastened to surfaces using appropriate accessories available from distributor. Please refer to data sheets or contact technical support for a copy. The use of glues and resins as fixing agents should be avoided. Use of glues and resins may invalidate the warranty of the product unless its use is agreed in writing by distributor as part of a detailed project specification.

The images indicate one type of fixing available in the accessories range. The different fixings serve obvious purposes, however when in doubt technical support should be contacted.

Quantities of accessories and fixings are dependent on the type and its effect on the variant it's being used with. Care should be taken to ensure drooping is avoided, and to ensure that is fastened adequately to avoid stresses on itself.

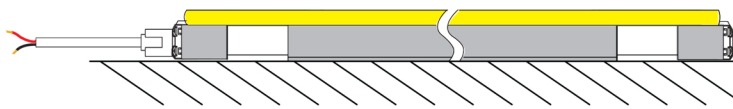
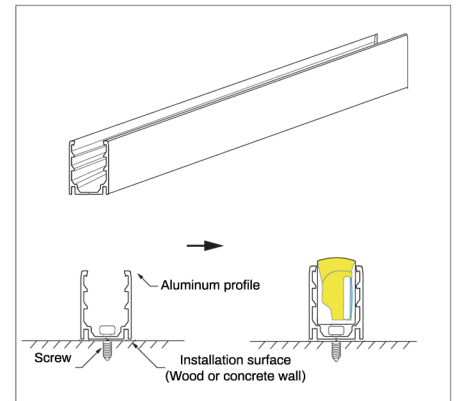

Press the flex light into mounted aluminum channel in one direction.

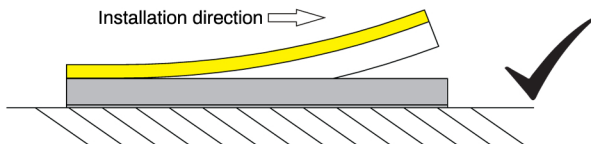

Incorrect installation like below picture could lead to light failure.

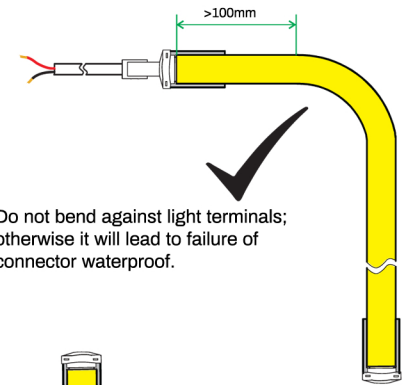
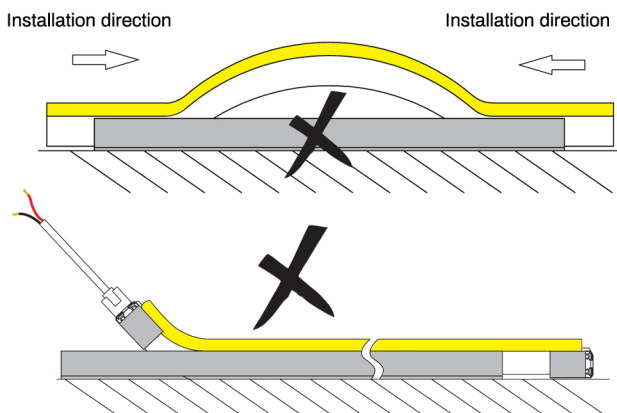

Do not bend against light terminals; otherwise it will lead to failure of connector waterproof.

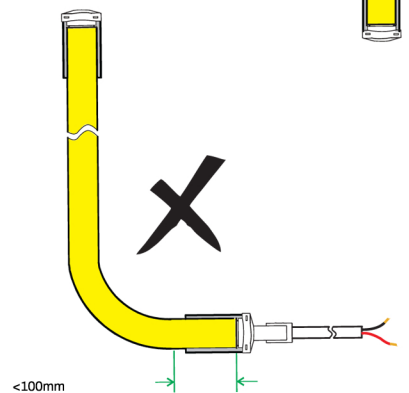

Ensure the feeding cable not bear force, keep the head 10mm in natural loose.

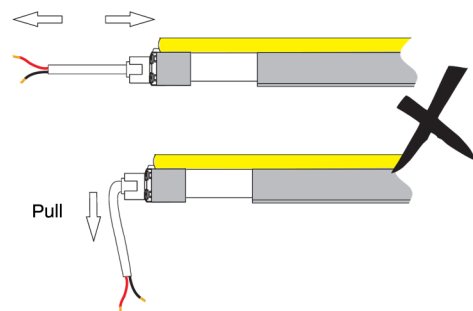
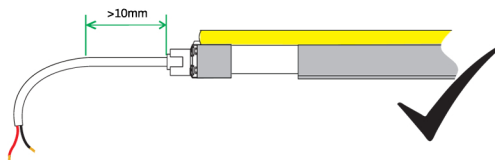

Mount the cable junction in hermetic enclosure like waterproof junction box in outdoor application.

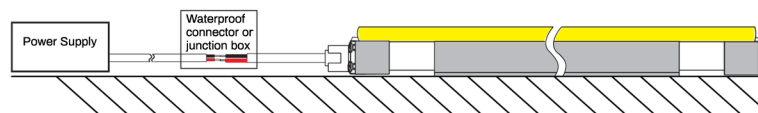

## INSTALL

### Attention

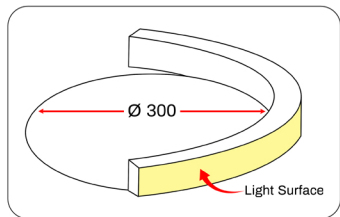

1. Correct bending way

### Intallation

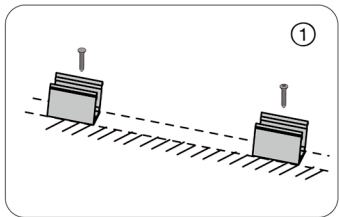

1. Installation of clip

Fix the clips and aluminum profile via the screws

⚠ Suggestion: 2pcs clips per meter.

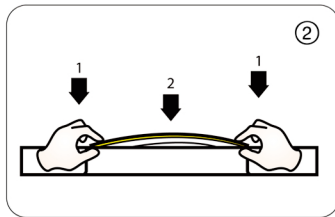

2. Installation of Neon

Simultaneously install the neon from both ends

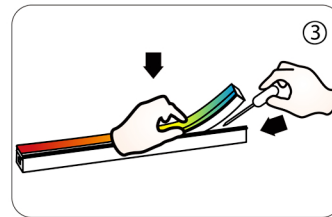

3. Installation of Neon

Should use tools to assist when remove the neon

### Cutting/Soldering/Intall end cap

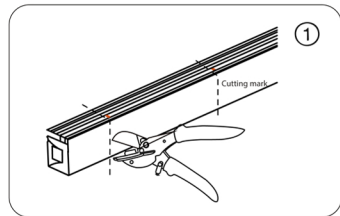

1. Cut the neon to be required length

⚠ The minimum cutting unit is based on the cutting mark.

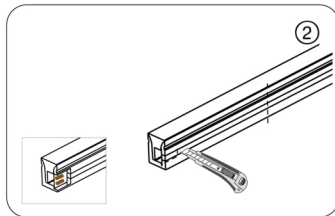

2. Cut the side of neon, expose the soldering pad

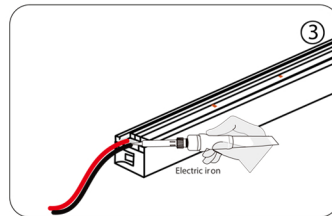

3. Solder the cable onto the PCB

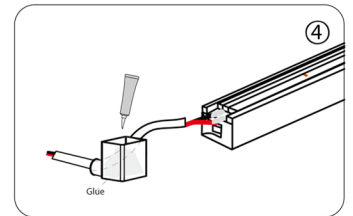

4. Put the wire into and inject glue into the end cap

⚠ The amount of glue is about 1/3-1/2 of end cap

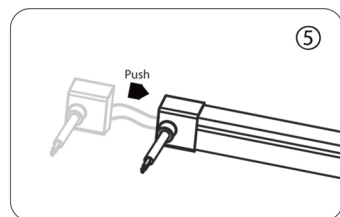

5. Push the end cap to wrap end of neon

⚠ After the glue is injected, the neon needs to be laid flat for 2 hours to before other process.

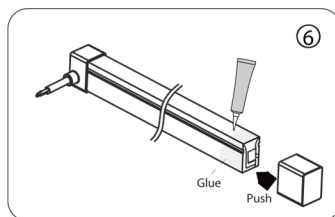

6. Apply gel around the tail of neon and install the end cap

⚠ After the glue is injected, the neon needs to be laid flat for 2 hours to before project process. Glue will complete dry after 24hours.

