

AQUA R/G/B

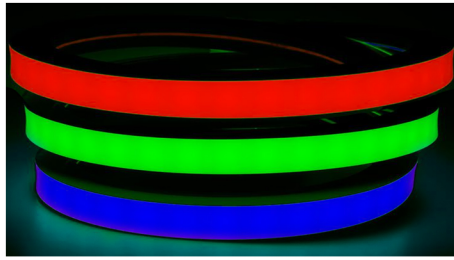

DESCRIPTION:

AQUA R/G/B vertical bend series constructed using Silicon extrusion process. Uniform, dot free light emission, good appearance consistency. Anti-yellowing, high temperature and corrosion resistance, weak acid and alkali resistance UV proof for true outdoor applications. Easy installation with clips and bendable track. Cuttable for Flexible application. Control mode : ON/OFF, DALI, Phase Cut, 0/1-10V.

TECHNICAL DETAILS:

Power : 10W/M
 Voltage : DC24V
 CRI >90
 Length/Reel : 5M/10M
 Cutting length: 100mm
 Led Qty : 60LEDs/M
 Pixels : 10 pixels/M
 Working Temperature : -25~55°C
 Storage Temperature : -30~80°C
 Voltage Range : 23 ~25V dc
 Reverse Voltage : 25V dc
 Warranty : 5 years

LUMENS PER METER:

CCT	10W
R	70lm
G	85lm
B	65lm

INSTALLATION : Vertical Bend

Product Code : 8981010



DIMENSION:

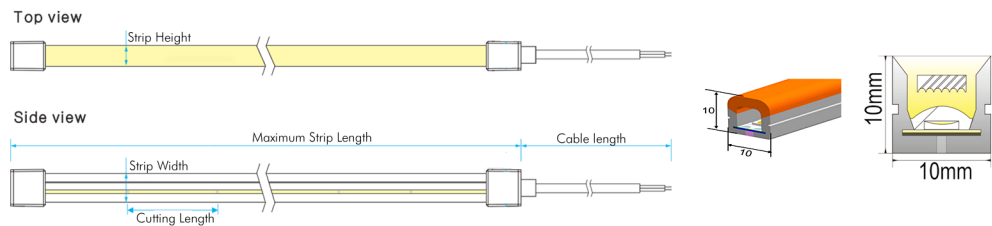

LIGHT DISTRIBUTION:

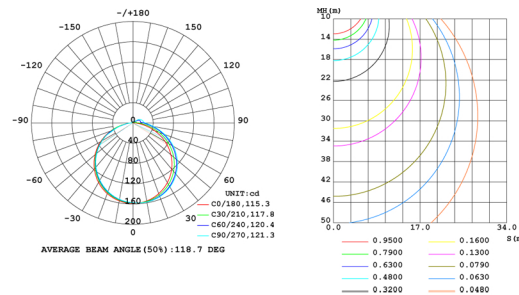

BENDING:

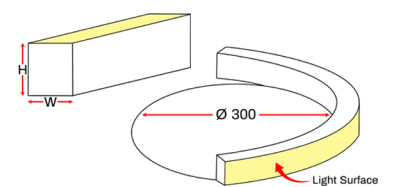

End cap

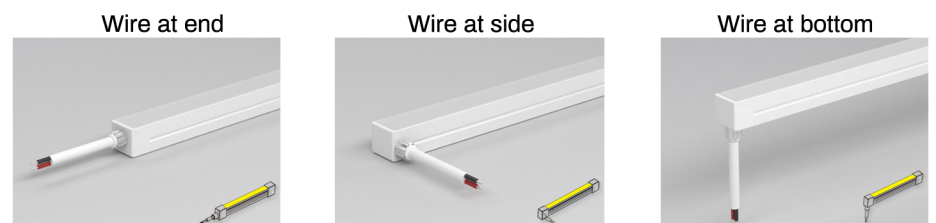

Standards

- EN 60598-1
- EN 60598-2-2
- EN 60598-3-2

Order Code Ex : 8981020	10	94
Product Code	Power	CCT
8981020	10-10W	94-R
		95-G
		96-B

Pluxb luminaires are developed with globally recognized and tested components suppliers, however as per international standards tolerance in initial flux and connected load is at ±5%. Unless stated otherwise, the values apply to an ambient temperature of 25°C

ACCESSORIES

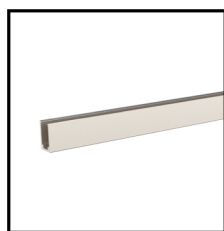

Aluminium Profile
Order Code: 8981010-01
Dimension:L1000xW13xH12.4mm
Material: aluminium
Color: silver

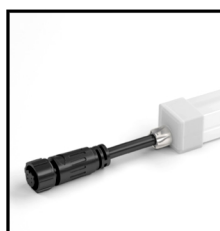

End Cap 2PIN Digital
Order Code: 8981010-08
Color: white
Cable entry: front/side/bottom
Picture: front

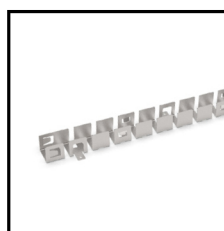

Curved Profile
Order Code: 8981010-02
Dimension:L1000xW14.3xH12mm
Material: stainless steel
Color: silver



Closed End Cap
Order Code: 8981010-09
Material: silicone
Color: white

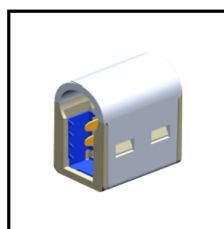

Neon to Neon
Order Code: 8981010-03



IP67 Signal Connector
Order Code: 8981010-10
Wire Gauge: 0.326mm²/22AWG
Protection: IP67 (Mated)

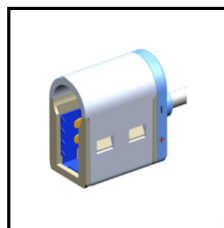

Neon to driver
Order Code: 8981010-04



IP67 T Type Connector
Order Code: 8981010-11
Wire Gauge: 0.326mm²/22AWG
Protection: IP67 (Mated)

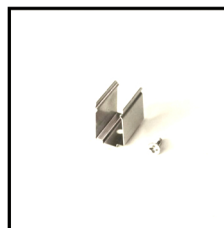

Mounting Clips
Order Code: 8981010-05
Dimension:L11.6xW8xH7.6mm
Material: stainless steel
Color: silver
Each meter led strips needs
2 clips + 2 screws

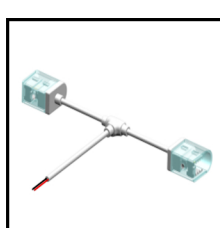

Neon cable neon
Order Code: 8981010-12



IP67 Connector 2PIN Digital
Order Code: 8981010-06
Wire gauge: 0.326mm²/22AWG
Protection: IP67 (Mated)



Scissor
Order Code: 8981010-13



IP67 Connector 2PIN Digital
Order Code: 8981010-07
Wire gauge: 0.326mm²/22AWG
Protection: IP67 (Mated)

ADDITIONAL INFO.

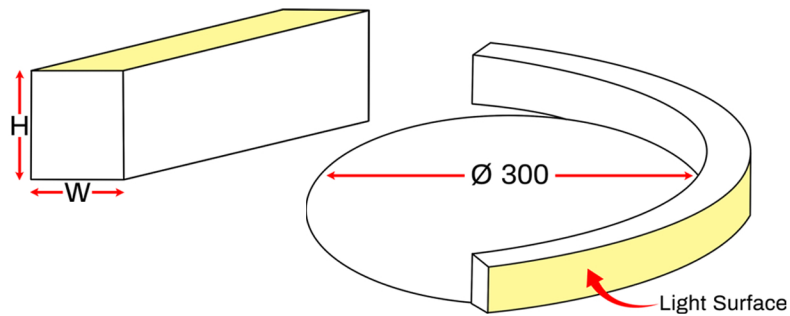

- ▶ Please light it up for a quick check before installation.
- ▶ Bending diameter of AQUA R/G/B 1010 is 300mm, do not bend to side direction, or bend too sharp or twist. If bend it wrongly, PCB inside will be damaged and the lighting fixture will not turn on.
- ▶ During installation, please make sure there are at least two workers to cooperate together and strictly follow the instruction manuals.
- ▶ Warranty: All LED light are warranted to be free from defects in product itself for 5 years from the date of purchase. This warranty does not cover failures due to abuse, misuse, improper handling, act of nature, negligence, normal wear, accidental damage, repairs made by the purchaser or incorrect voltage conditions.

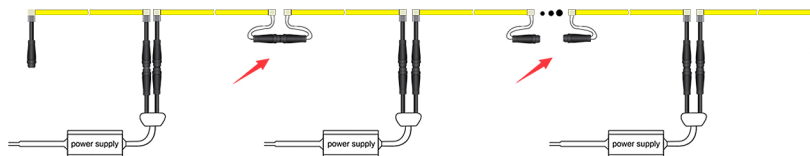

Note:

-10W/M Max. 10mtr run length to single side feed.

-The given data are typical values due to the tolerances of the production process and the electrical components, values for light output and electrical power can vary up to 5%.

GENERAL MOUNTING

LED neon flex can be fastened to surfaces using appropriate accessories available from distributor. Please refer to data sheets or contact technical support for a copy. The use of glues and resins as fixing agents should be avoided. Use of glues and resins may invalidate the warranty of the product unless its use is agreed in writing by distributor as part of a detailed project specification.

The images indicate one type of fixing available in the accessories range. The different fixings serve obvious purposes, however when in doubt technical support should be contacted.

Quantities of accessories and fixings are dependent on the type and its effect on the variant it's being used with. Care should be taken to ensure drooping is avoided, and to ensure that is fastened adequately to avoid stresses on itself.

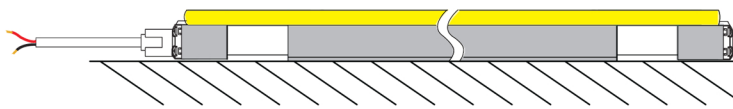
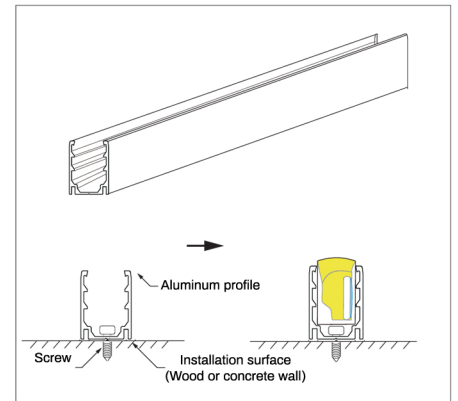

Press the flex light into mounted aluminum channel in one direction.

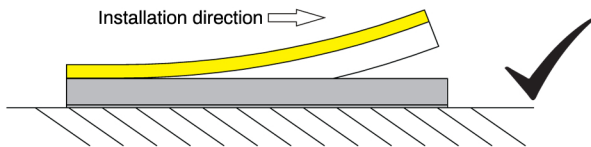

Incorrect installation like below picture could lead to light failure.

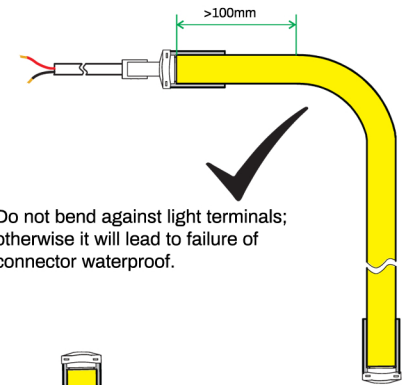
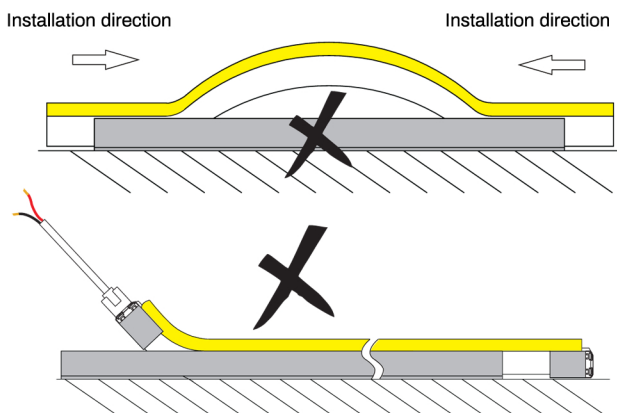

Do not bend against light terminals; otherwise it will lead to failure of connector waterproof.

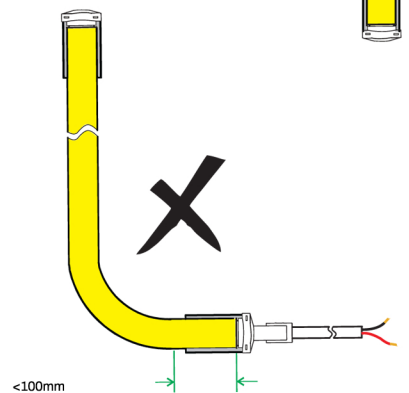

Ensure the feeding cable not bear force, keep the head 10mm in natural loose.

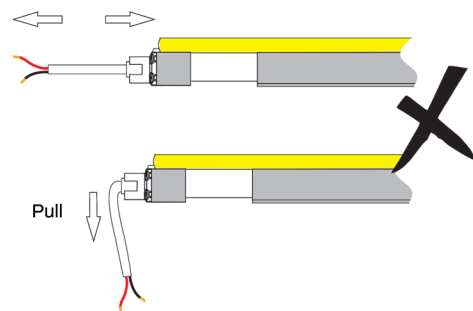
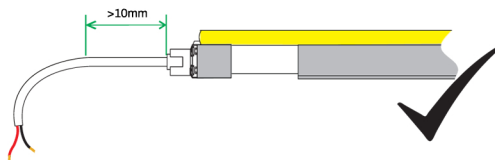

Mount the cable junction in hermetic enclosure like waterproof junction box in outdoor application.

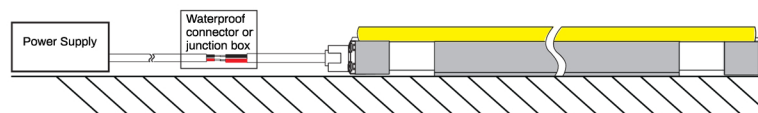

WIRING DIAGRAM

ON/OFF

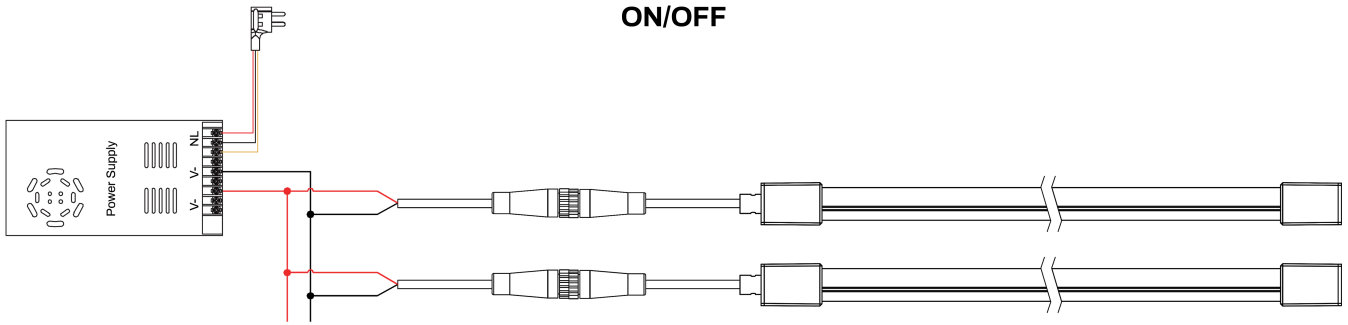

0/1-10V

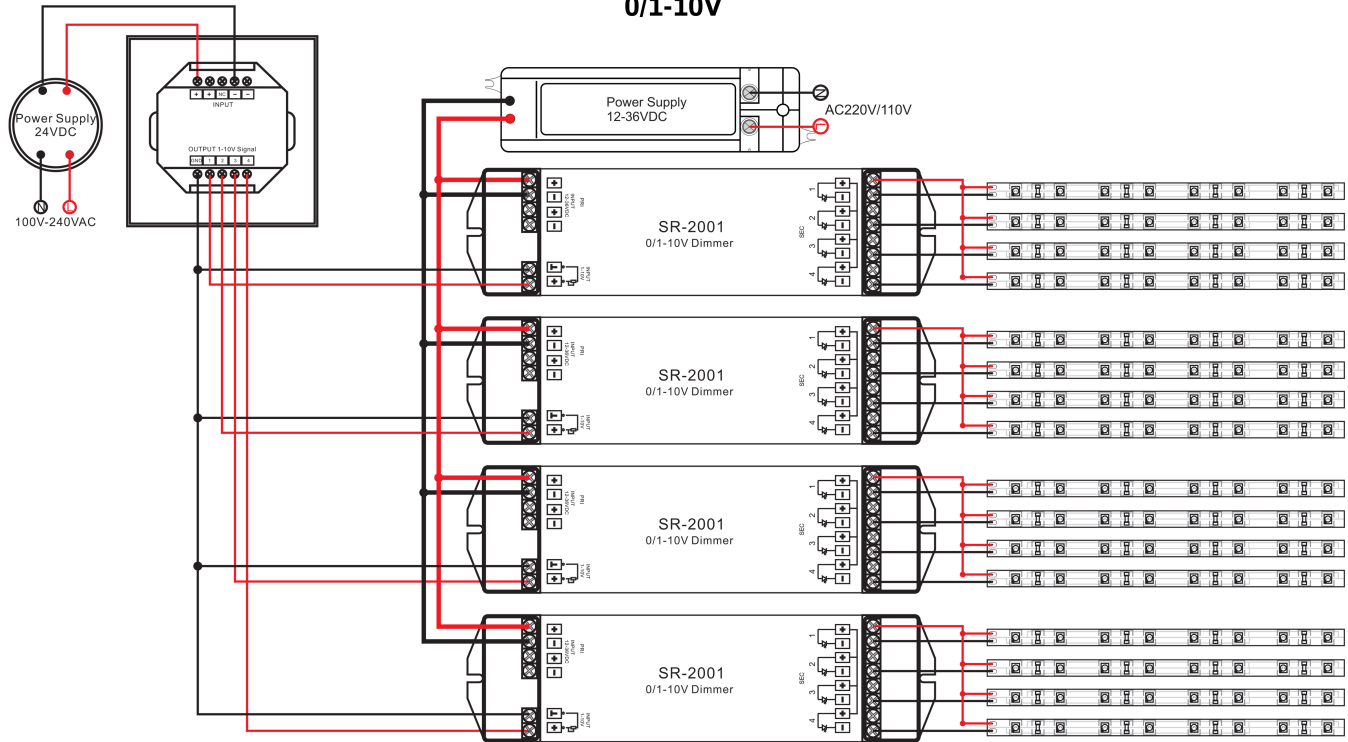

1. DALI

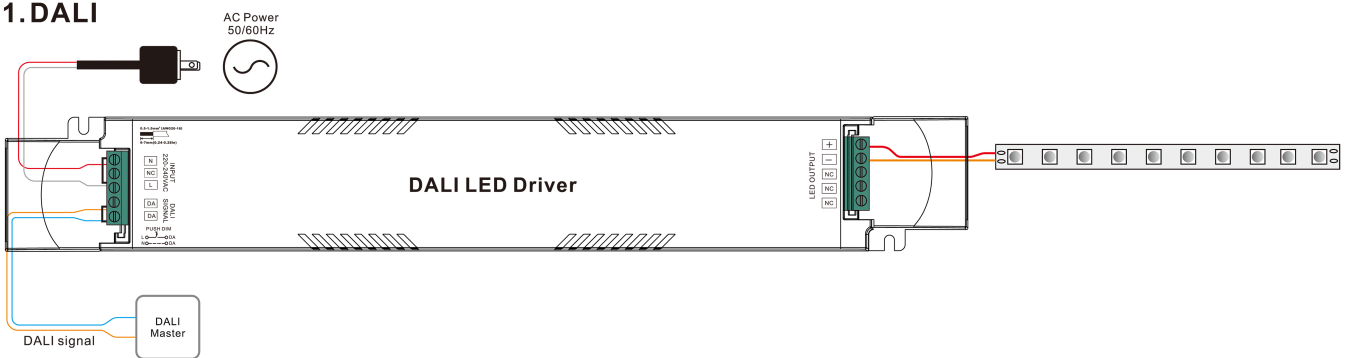

2. With Push Dim

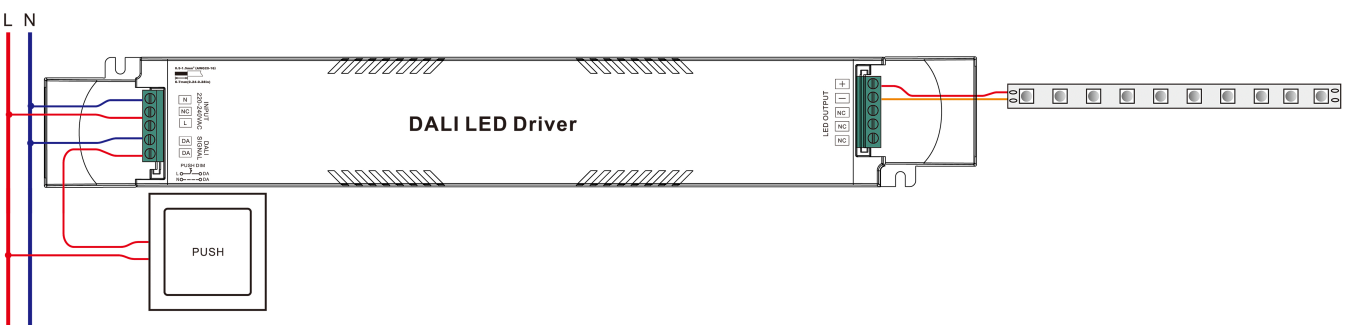

INSTALL

Attention

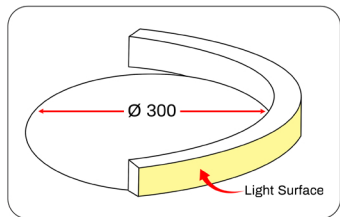

1. Correct bending way

Installation

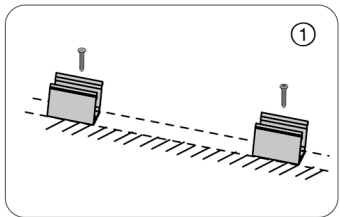

1. Installation of clip

Fix the clips and aluminum profile via the screws

⚠ Suggestion: 2pcs clips per meter.

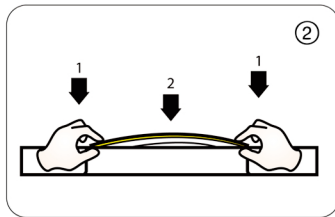

2. Installation of Neon

Simultaneously install the neon from both ends

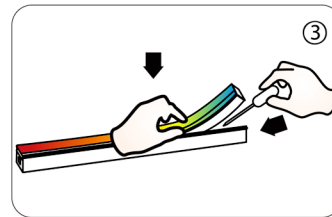

3. Installation of Neon

Should use tools to assist when remove the neon

Cutting/Soldering/Intall end cap

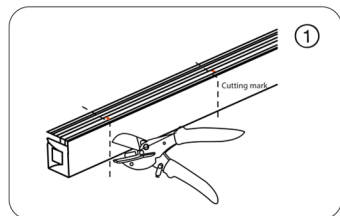

1. Cut the neon to be required length

⚠ The minimum cutting unit is based on the cutting mark.

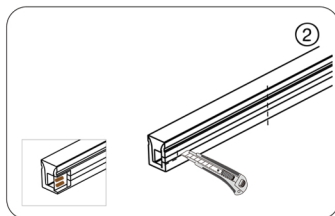

2. Cut the side of neon, expose the soldering pad

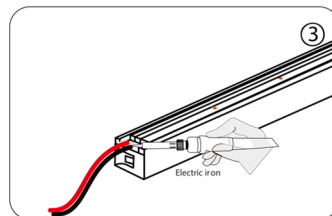

3. Solder the cable onto the PCB

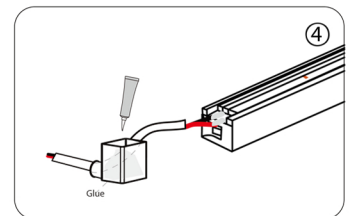

4. Put the wire into and inject glue into the end cap

⚠ The amount of glue is about 1/3-1/2 of end cap

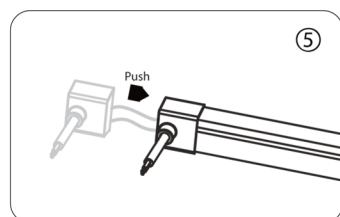

5. Push the end cap to wrap end of neon

⚠ After the glue is injected, the neon needs to be laid flat for 2 hours to before other process.

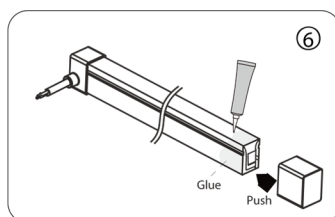

6. Apply gel around the tail of neon and install the end cap

⚠ After the glue is injected, the neon needs to be laid flat for 2 hours to before project process. Glue will complete dry after 24hours.

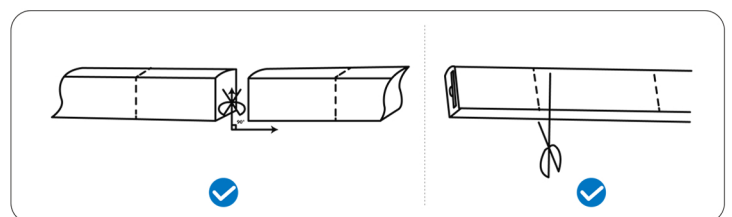

INSTALL

Installation of No-Soldering Connector

1. Installation of power cord connector

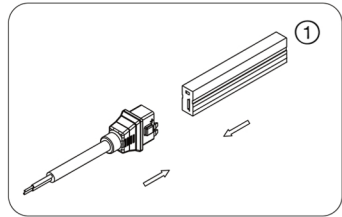

1. Push Neon into the connector

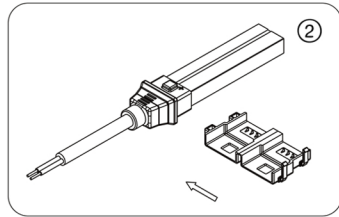

2. Wrap the connector with the faster

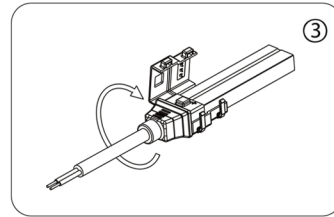

3. Press the fastener, let the bayonet slid into the corresponding slot

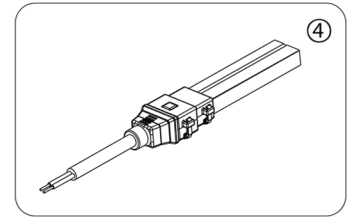

4. Check if nstallation is firm & in place

2. Installation of connector

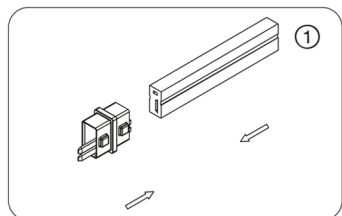

1. Push 1st part neon into the connector

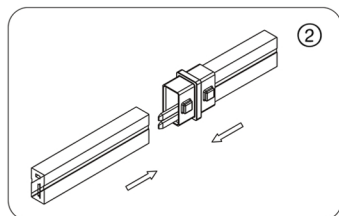

2. Push 2nd strip light part into another end

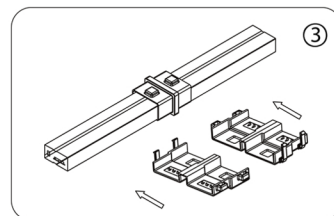

3. Wrap the both sides of connector with the fastener

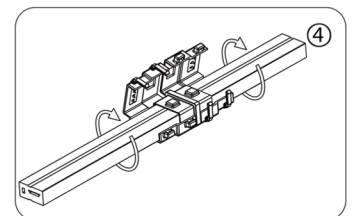

4. Press the fastener, let the bayonet slid into the corresponding slot

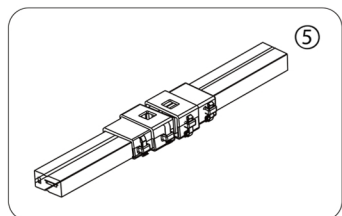

1. Check if installation is firm & in place



Note: We need to add glue to make the connection waterpr oof.

CUTTING

Buckle install distance schematic diagram

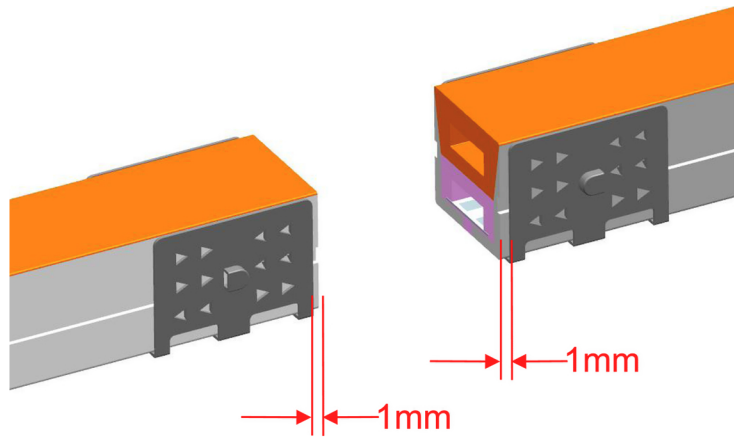

Note: The install distance between buckle and cutting section is $\pm 1\text{mm}$

Match strip dimensions: 10x10mm.

Type power to strip connecotor assembly drawing

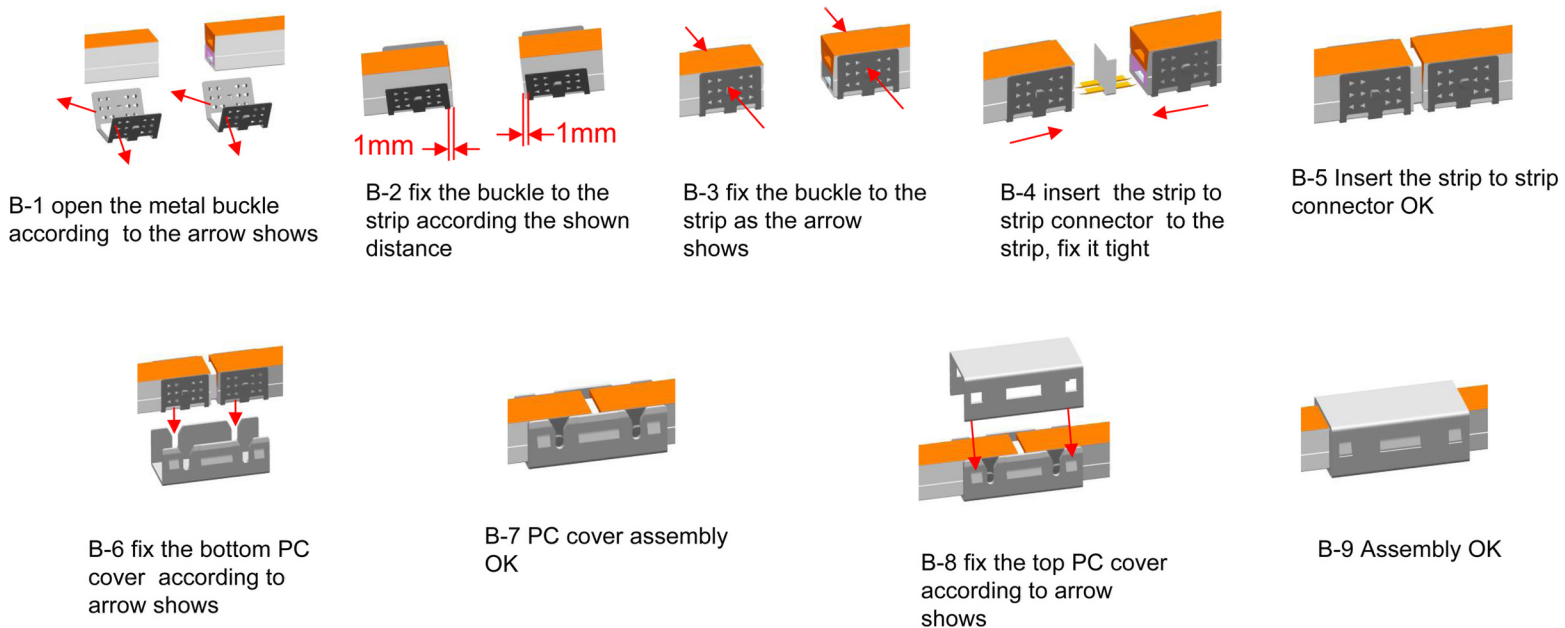

Match strip dimensions: 10x10mm.

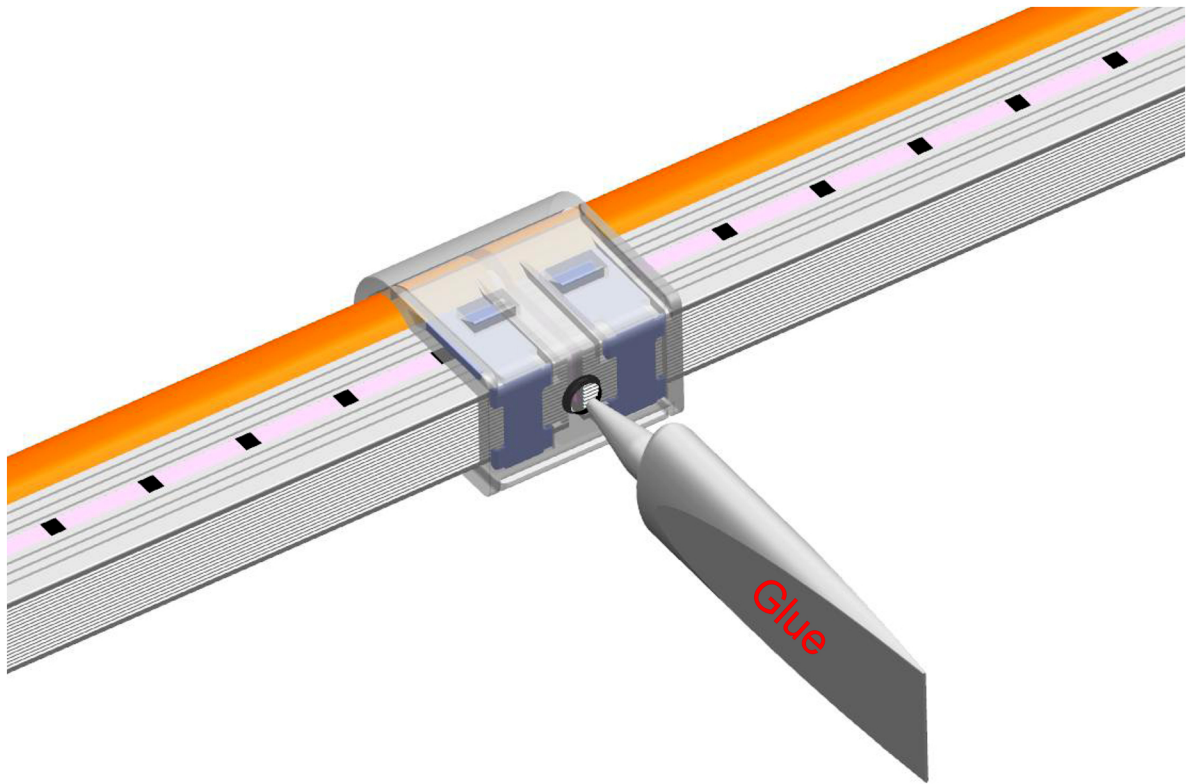

If the strips need to be IP67 waterproof rated, please make sure the connector installed correctly, strip lights up properly. Then pour the glue to the injection port, until the glue fills the entire connector and overflows to the surface of strip. Once glue injected OK, wait for 3-5 hours to make it IP67 waterproof rated.